

Battery

The battery is located in a compartment under the seat.

UNDER SEAT

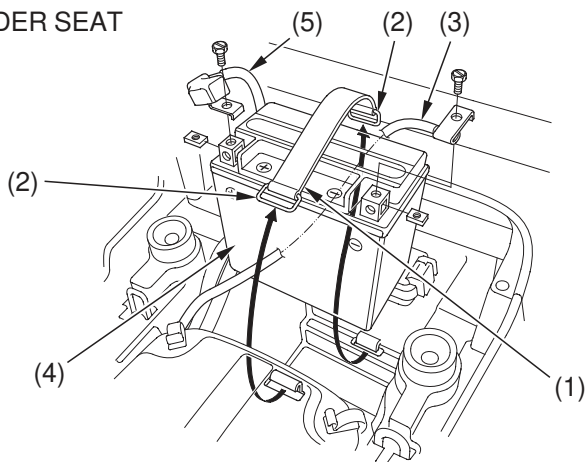

- | | |
|--------------------------------|--------------------------------|
| (1) rubber band | (4) battery |
| (2) rings | (5) positive (+) terminal lead |
| (3) negative (-) terminal lead | |

Removal

1. Make sure the ignition switch is OFF (\bigcirc).
2. Remove the seat (page 116).
3. Remove the rubber band (1) by releasing the rings (2).
4. Disconnect the negative (-) terminal lead (3) from the battery (4) first, then disconnect the positive (+) terminal lead (5).
5. Remove the battery.