

Controls & Features

Drive Mode Select Switch

The drive mode select switch (1) has two positions, AUTO and ESP. See *Shifting Gears* page 76.

RIGHT HANDLEBAR

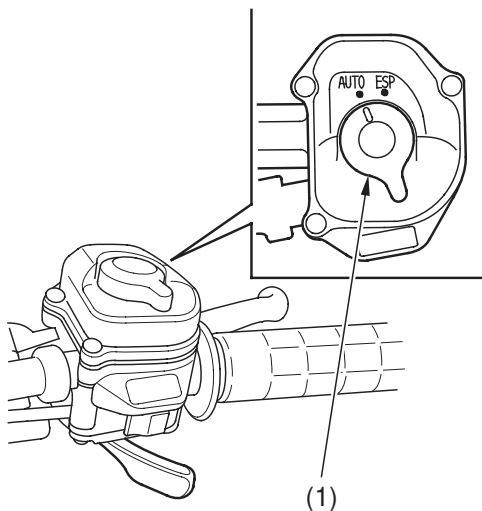

(1) drive mode select switch