

## Right Side Cover

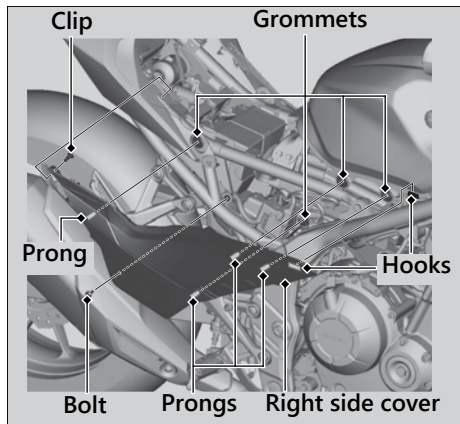

### Removal

1. Remove the front seat. ► P. 62
2. Remove the bolt and clip. ► P. 61
3. Remove the prongs from the grommets, then remove the right side cover by releasing the hooks.

### Installation

Install the parts in the reverse order of removal.