

Engine Guard & Skid Plates

Refer to *Safety Precautions* on page 85.

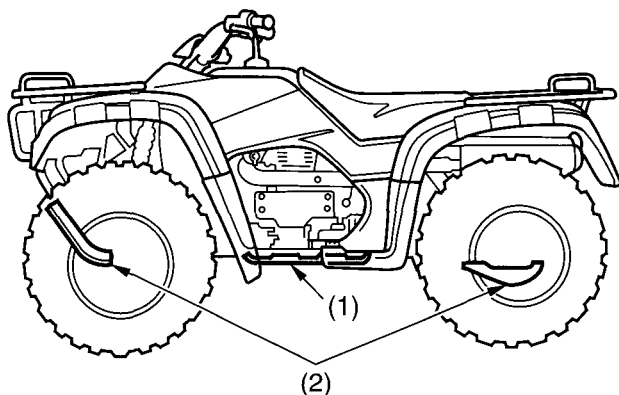

(1) engine guard

(2) skid plates

The engine guard (1) protects the engine crankcase.

The skid plates (2) protect the frame and rear final gear case. Check the guard and plates for cracks, damage or looseness at intervals shown in the Maintenance Schedule.

Have the engine guard and skid plates replaced if they are cracked or damaged. If the guard and plate bolts are loose, tighten them securely.