

Differential Oil

1. Park the ATV on level ground.
2. Place an oil drain pan under the oil drain plug (1).
3. Remove the oil filler cap (2) and the drain plug.
4. After the oil has completely drained, reinstall the drain plug and tighten it to the specified torque:
9 lbf·ft (12 N·m , 1.2 kgf·m)
5. Fill the differential with the recommended oil.
8.2 US oz (241 cm³ , 8.5 Imp oz)
Make sure the oil level is at the lower edge of the oil filler inspection hole (3).
6. Install the oil filler cap.

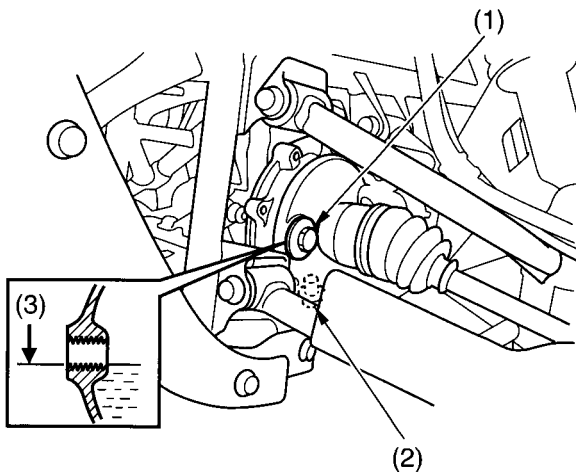

(1) oil drain plug
(2) oil filler cap

(3) oil filler inspection hole