

DRIVESHAFT BOOTS

Check the rubber driveshaft boots (1) for damage or leaking grease. If necessary, have your authorized Honda dealer replace them.

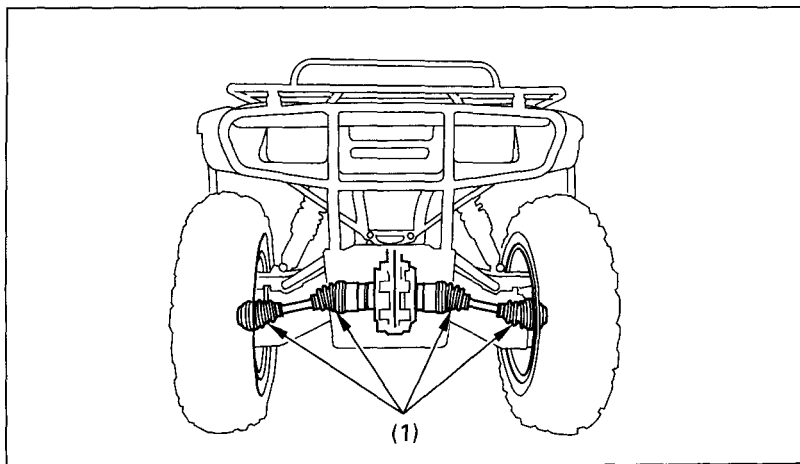

Fig. 4-41

(1) Driveshaft boots