

## LIGHTS

### Headlight and Dimmer Switches

The headlight and dimmer switches (Fig. 2-17) are above the engine stop switch, next to the left handgrip.

Turning the headlight switch (1) ☼ (ON) turns the headlight on. Use the dimmer switch (2) to select either high beam ≡D (HI) or low beam ≡D (LO).

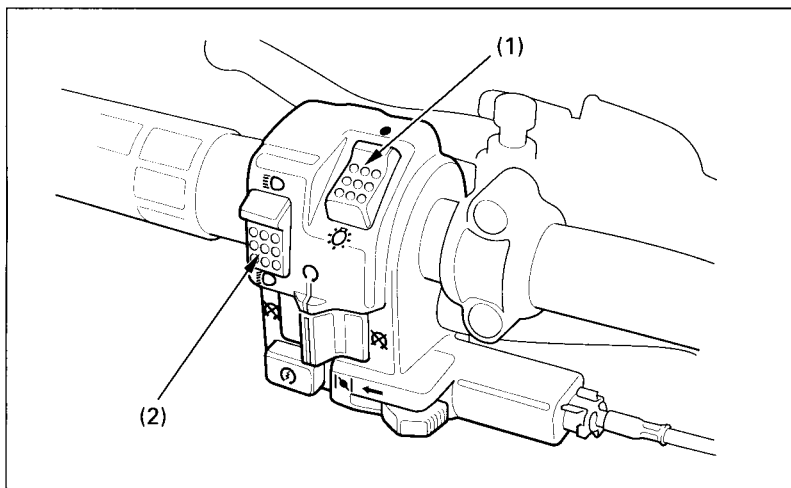

Fig. 2-17 (1) Headlight switch (2) Dimmer switch

### Oil High Temperature Indicator Lamp

If the engine oil gets too hot, the oil high temperature indicator lamp (Fig. 2-18) will light.

#### NOTE:

The oil high temperature indicator lamp should come on when the ignition switch is turned I (ON). This is not a problem. The light should go off a few seconds after the engine is started.

#### CAUTION:

**If the light does not come on with ignition switch I (ON): check the bulb and replace it if it is burned out.**

**Contact your authorized Honda dealer for assistance if you cannot correct the problem.**