

MAINTENANCE

Installation:

1. Reassemble the removed parts in the reverse order of removal.

- Position the wheel between the fork legs and insert the front axle shaft from the left side, through the left fork leg and wheel hub.
- Align the end of axle shaft with the surface of fork leg.
- Fit the brake disc carefully between the brake pads to avoid damaging the pads.

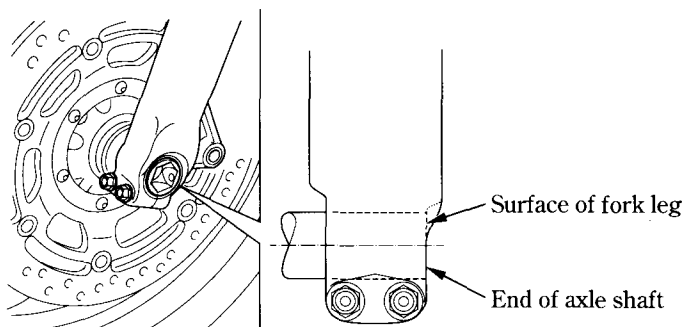

2. Install the bolts and tighten to the specified torque:

axle bolt:

78 N·m (8.0 kgf·m , 58 lbf·ft)

right caliper fixing bolts:

31 N·m (3.2 kgf·m , 23 lbf·ft)

left caliper socket bolts:

31 N·m (3.2 kgf·m , 23 lbf·ft)

3. Measure the clearance between the brake disc and the caliper holder on each side with a 0.7 mm (0.028 in) feeler gauge.

- If the feeler gauge inserts easily, remove it and tighten the axle pinch bolts to the specified torque:
22 N·m (2.2 kgf·m , 16 lbf·ft)
- If the feeler gauge cannot be inserted easily, loosen the left axle pinch bolt and pull the left fork outward or push inward to adjust the clearance. Then tighten the axle pinch bolts to the specified torque.