

Stop/Taillight Bulb

1. Open the rear seat (page 42).
2. Turn the socket (1) 90° counterclockwise, then pull it out toward you.

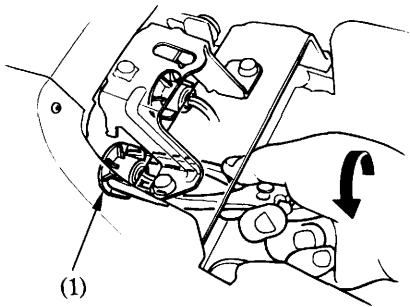

(1) Socket

3. Slightly press down on the bulb (2) and turn it counterclockwise.
4. Install a new bulb in the reverse order of removal.

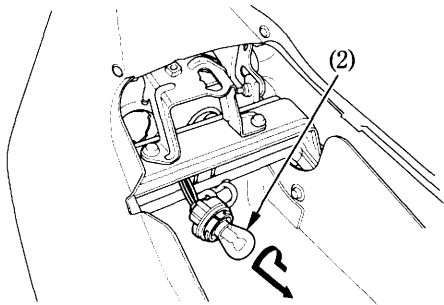

(2) Bulb